

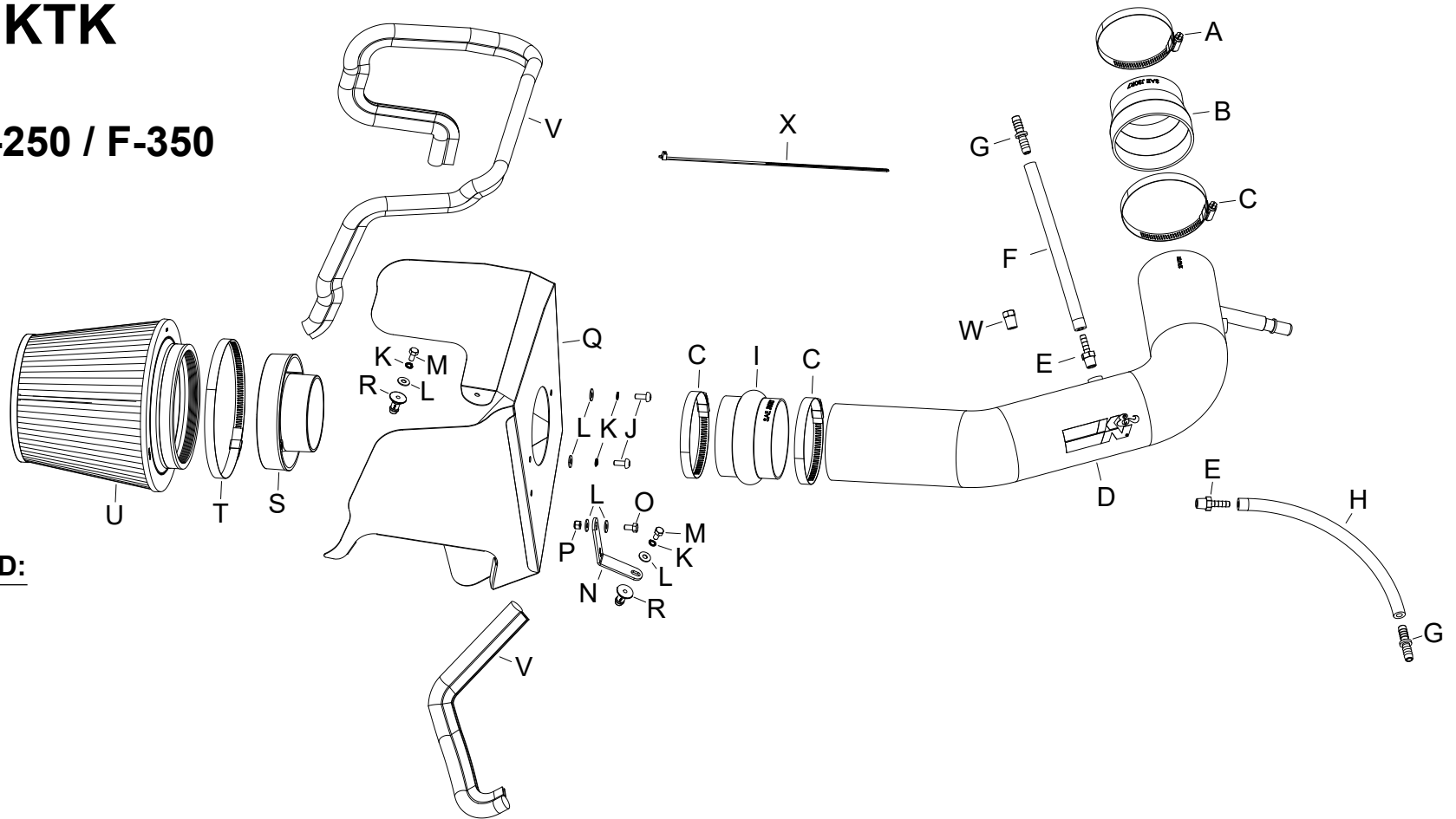

NOT LEGAL FOR SALE OR USE ON ANY POLLUTION CONTROLLED MOTOR VEHICLE IN CALIFORNIA OR STATES ADOPTING CALIFORNIA EMISSION PROCEDURES.
See knfilters.com for CARB status on each part for a specific vehicle

INSTALLATION INSTRUCTIONS

77-2588KTK
FORD
2017-19 F-250 / F-350
V8-6.2L



TOOLS NEEDED:

Flat blade screw driver
ratchet
extension
10mm socket
10mm wrench
4mm allen key

PARTS LIST:

Description	Qty.	Part #	Description	Qty.	Part #	Description	Qty.	Part #
A HOSE CLAMP #56	1	08620	I HOSE; 4" ID X 3" L HUMP	1	08418	Q HEAT SHIELD	1	073251
B HOSE; 4"ID TO 3-1/2"ID X 3"L	1	08497	J BOLT; M6 X 1.00 X 16MM, SS	2	07730	R MOUNT, PLASTIC AIRBOX	2	8-186-1
C HOSE CLAMP #64 STAINLESS	3	08645	K WASHER, M6 SPLIT LOCK ZINC	4	1-3025	S ADAPTOR; 57-3058 #454	1	27300
D INTAKE TUBE	1	27675TK	L WASHER; 6MM FLAT, SS	6	08269	T HOSE CLAMP; #104	1	08697
E VENT; STRT, 3/8"HOSE, 1/4"	2	08047	M BOLT; M6 X 1.00 X 12MM, SS	2	07727	U FILTER CHARGER	1	RC-5179
F HOSE; 3/8"ID X 8"L	1	5-1008	N BRACKET; L, 63-2597, STL	1	064346	V EDGE TRIM (57")	1	102470
G VENT; STRT 3/8"HOSE	2	08041	O BOLT; 6MM-1.00 X 16MM, SS	1	07812	W PLUG; 1/4 NPT, PLASTIC	1	08032
H HOSE; 3/8"ID X 6"L	1	5-1006	P NUT; 6MM NYLOCK, HEXHEAD	1	07512	X CABLE TIES; 11" BLACK	1	21590

If you need any assistance please call 1-800-858-3333 to speak with a representative in our Customer Service Center before returning the product.

NOTE: FAILURE TO FOLLOW INSTALLATION INSTRUCTIONS AND NOT USING THE PROVIDED HARDWARE MAY DAMAGE THE INTAKE TUBE, THROTTLE BODY AND ENGINE.

TO START:

1. Turn off the ignition and disconnect the negative battery cable.
NOTE: Disconnecting the negative battery cable erases pre-programmed electronic memories. Write down all memory settings before disconnecting the negative battery cable. Some radios will require an anti-theft code to be entered after the battery is reconnected. The anti-theft code is typically supplied with your owner's manual. In the event your vehicles anti-theft code cannot be recovered, contact an authorized dealership to obtain your vehicles anti-theft code.

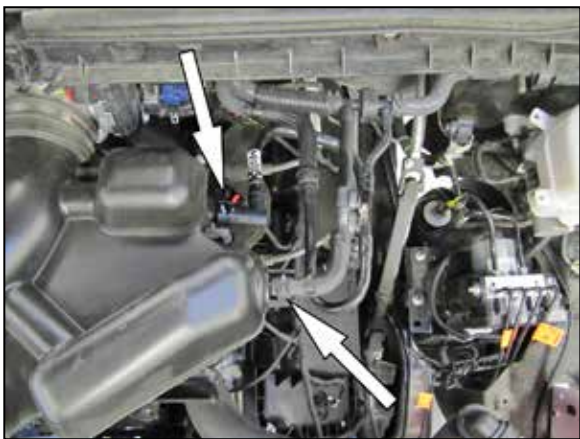

2. Release the spring clamp that secures the EVAP vent line to the intake plenum. Then release the locking tap on the Crankcase vent fitting and disconnect the crank case vent from the intake plenum.



3. Disconnect the vent line from the intake plenum where shown, then unhook the heater hose clip from the intake plenum.
NOTE: Some vehicles may not be equipped with this vent line.



4. Loosen the hose clamps that secure the intake plenum to the air filter housing and to the throttle body, then remove the intake plenum from the vehicle.



5. Unhook the wiring pigtail from the upper air filter housing.
NOTE: Some vehicles may not have this pigtail attached.



6. Remove the two bolts that secure the air filter housing to the mounting bracket and remove the air filter housing from the vehicle.
NOTE: K&N Engineering, Inc., recommends that customers do not discard factory air intake.



7. Remove the two bolts that secure the air filter mounting bracket to the fender and then remove the bracket from the vehicle.

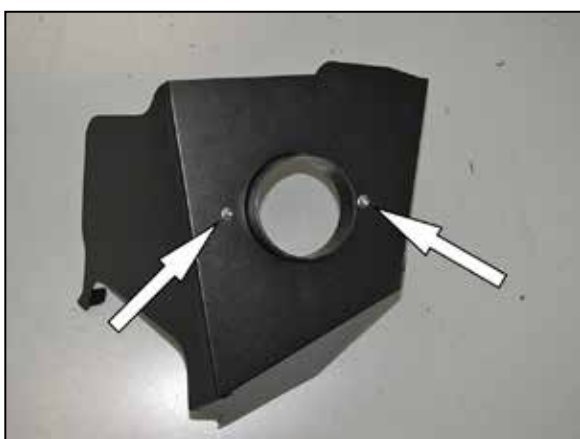

8. Install the air filter adapter through the heat shield and secure with the provided hardware.

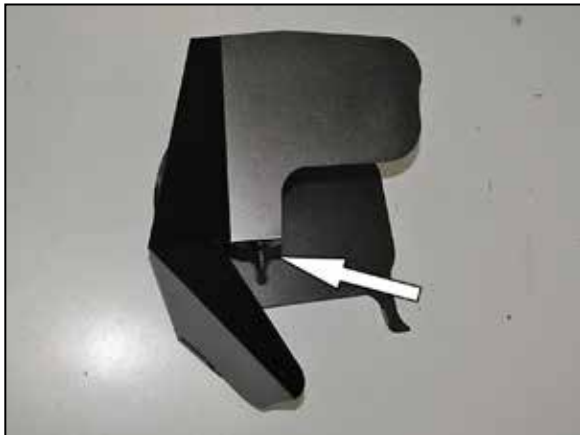

9. Install the mounting stud onto the heat shield using the provided hardware.

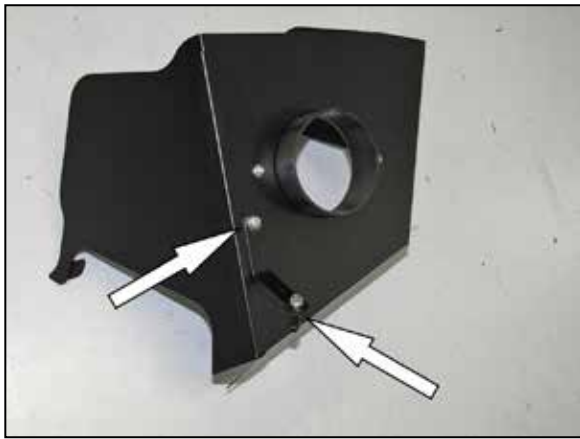

10. Install the mounting bracket (064346) onto the heat shield and then install the remaining mounting stud onto the bracket as shown using the provided hardware.

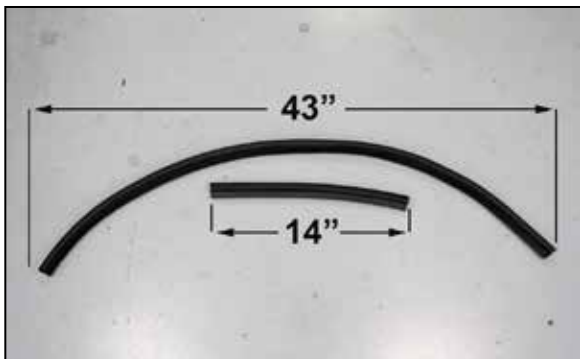

11. Cut the provided edge trim into two lengths as shown. One section should be 14" long and the other section should be 43" long.



12. Install the edge trim onto the heat shield as shown.



13. Install the K&N® air filter onto the filter adapter and secure with the provided hose clamp.
NOTE: Drycharger® air filter wrap; part # RC-5139DK is available to purchase separately. To learn more about Drycharger® filter wraps or look up color availability please visit <http://www.knfilters.com>®.



14. Install the heat shield assembly into the vehicle so that the mounting studs insert into the factory air filter housing grommet locations.



15. Install the provided hump coupler (08418) onto the filter adapter and secure with the provided hose clamp.



16. Install the provided step coupler (08497) onto the throttle body and secure with the provided hose clamp.



17. Secure the wiring pigtail from step #5 to the A/C line with the provided tie wrap.



18. Install the two provided NPT vent fittings into the K&N® intake tube as shown.
NOTE: On vehicles that only have one vent line, install the provided 1/4npt plug in its place. NOTE: Plastic NPT fittings are easy to cross thread. Install the vent fitting "hand" tight, then turn it two complete turns with a wrench.



19. Install the K&N® intake tube into the hump coupler and then into the step coupler at the throttle body, adjust the tube for best fit and then secure with the provided hose clamps.



20. Install the two provided hose menders into the provided vent hoses as shown.

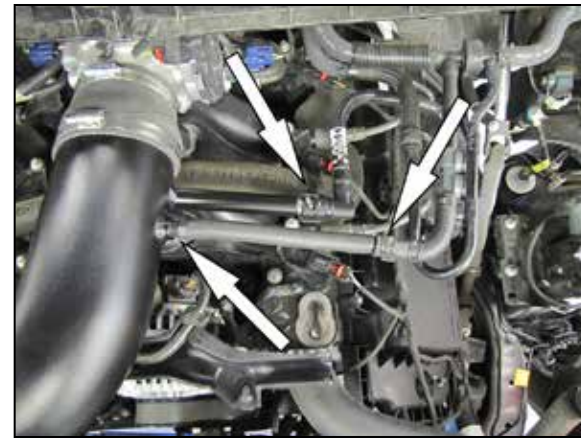

21. Install the shorter vent hose assembly onto the K&N® intake tube and then connect the other end into the EVAP vent line.



22. Install the longer vent hose assembly onto the K&N® intake tube and then into the factory vent line as shown.



23. Reconnect the vehicle's negative battery cable. Double check to make sure everything is tight and properly positioned before starting the vehicle.

24. It will be necessary for all K&N® high flow intake systems to be checked periodically for realignment, clearance and tightening of all connections. Failure to follow the above instructions or proper maintenance may void warranty.

ROAD TESTING:

1. Start the engine with the transmission in neutral or park, and the parking brake engaged. Listen for air leaks or odd noises. For air leaks secure hoses and connections. For odd noises, find cause and repair before proceeding. This kit will function identically to the factory system except for being louder and much more responsive.

2. Test drive the vehicle. Listen for odd noises or rattles and fix as necessary.

3. If road test is fine, you can now enjoy the added power and performance from your kit.

4. K&N Engineering, Inc., requires cleaning the intake system's air filter element every 100,000 miles. When used in dusty or off-road environments, our filters will require cleaning more often. We recommend that you visually inspect your filter once every 25,000 miles to determine if the screen is still visible. When the screen is no longer visible some place on the filter element, it is time to clean it. To clean and re-oil, purchase our filter Recharger® service kit, part number 99-5050 or 99-5000 and follow the easy instructions.

NOT LEGAL FOR SALE OR USE ON ANY POLLUTION CONTROLLED MOTOR VEHICLE IN CALIFORNIA OR STATES ADOPTING CALIFORNIA EMISSION PROCEDURES.

See knfilters.com for CARB status on each part for a specific vehicle